

-
-
-
-
-
-
-
-
-
-

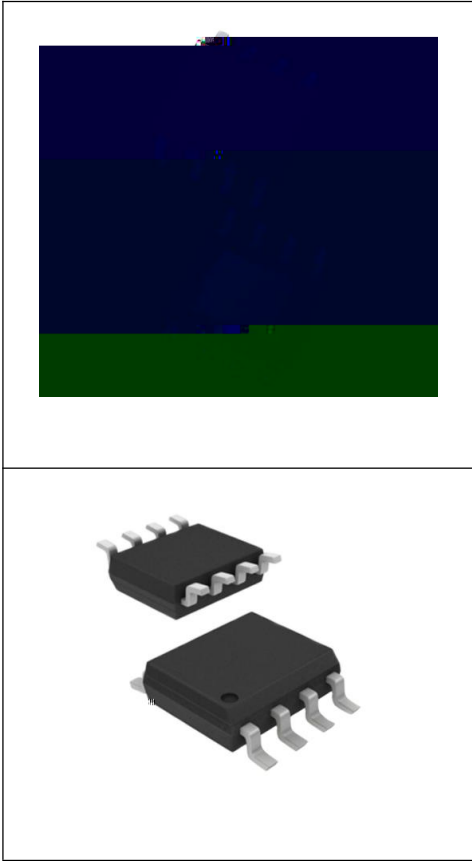

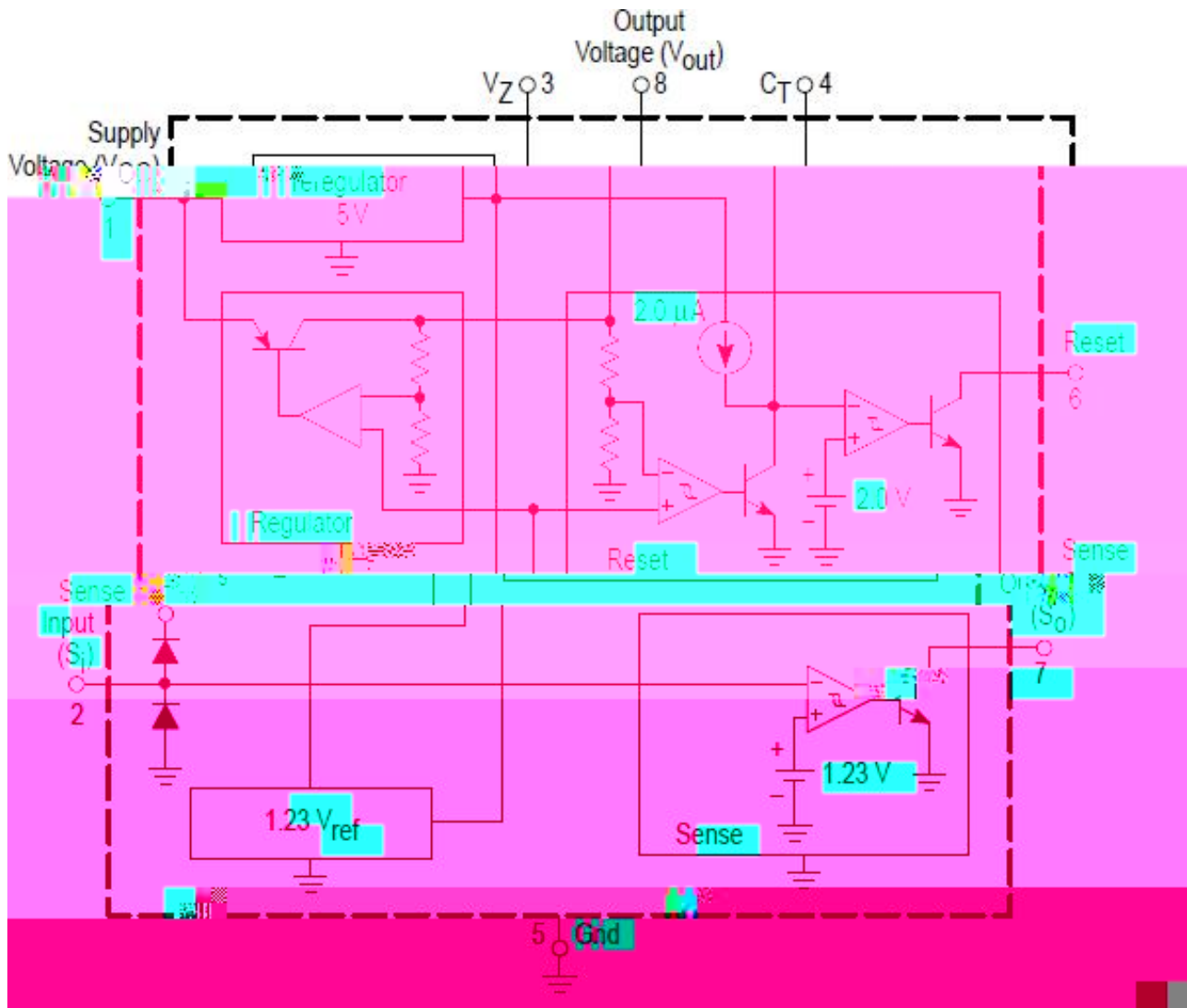

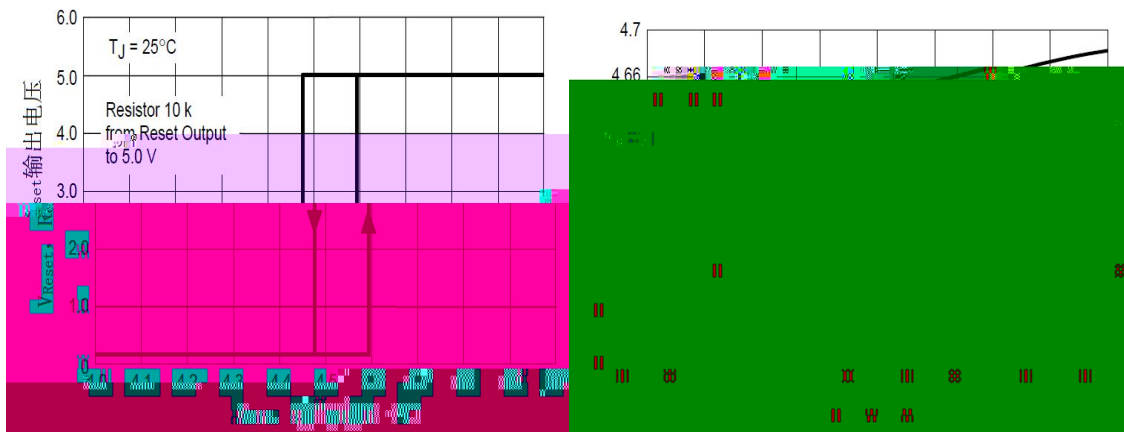

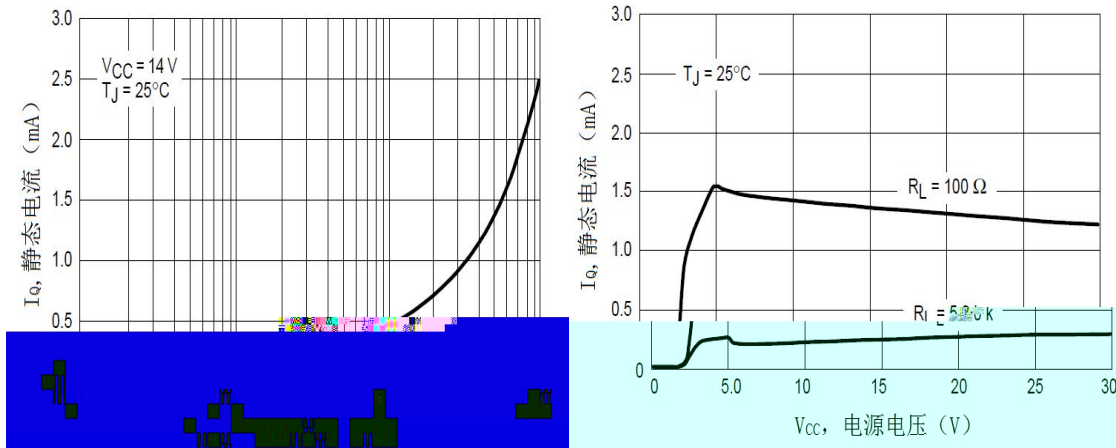
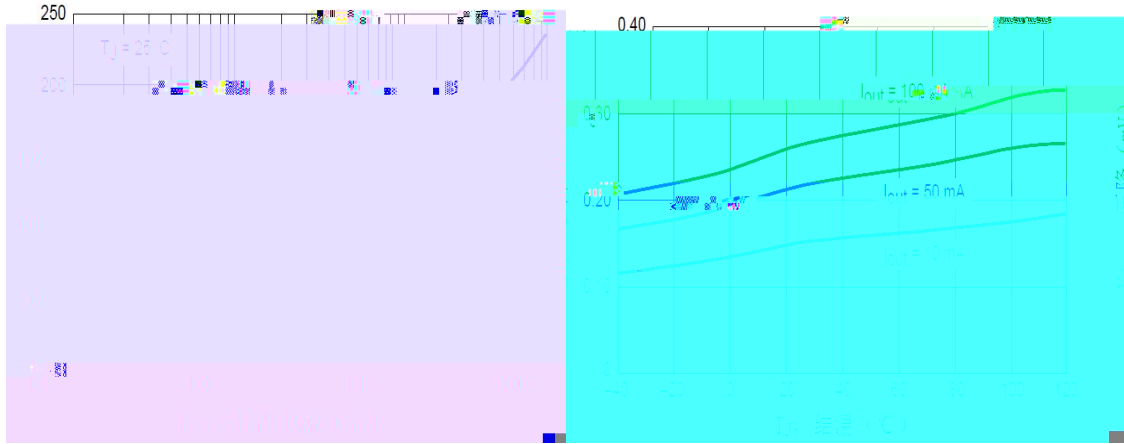
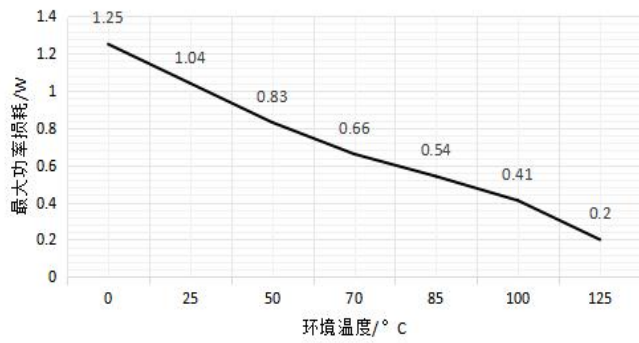
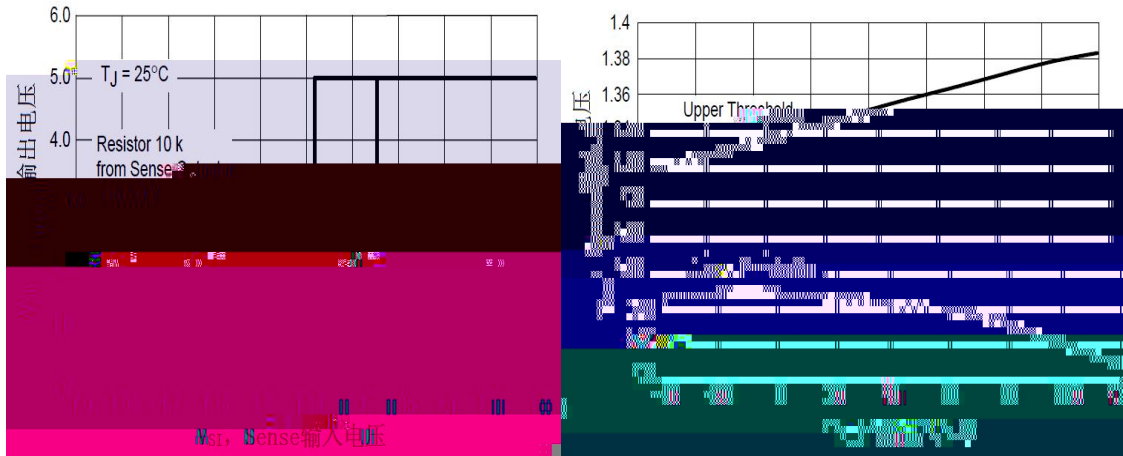



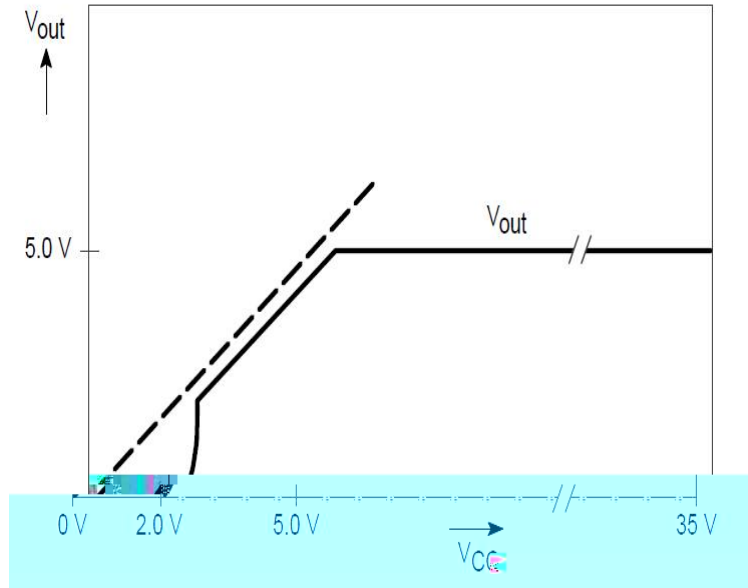

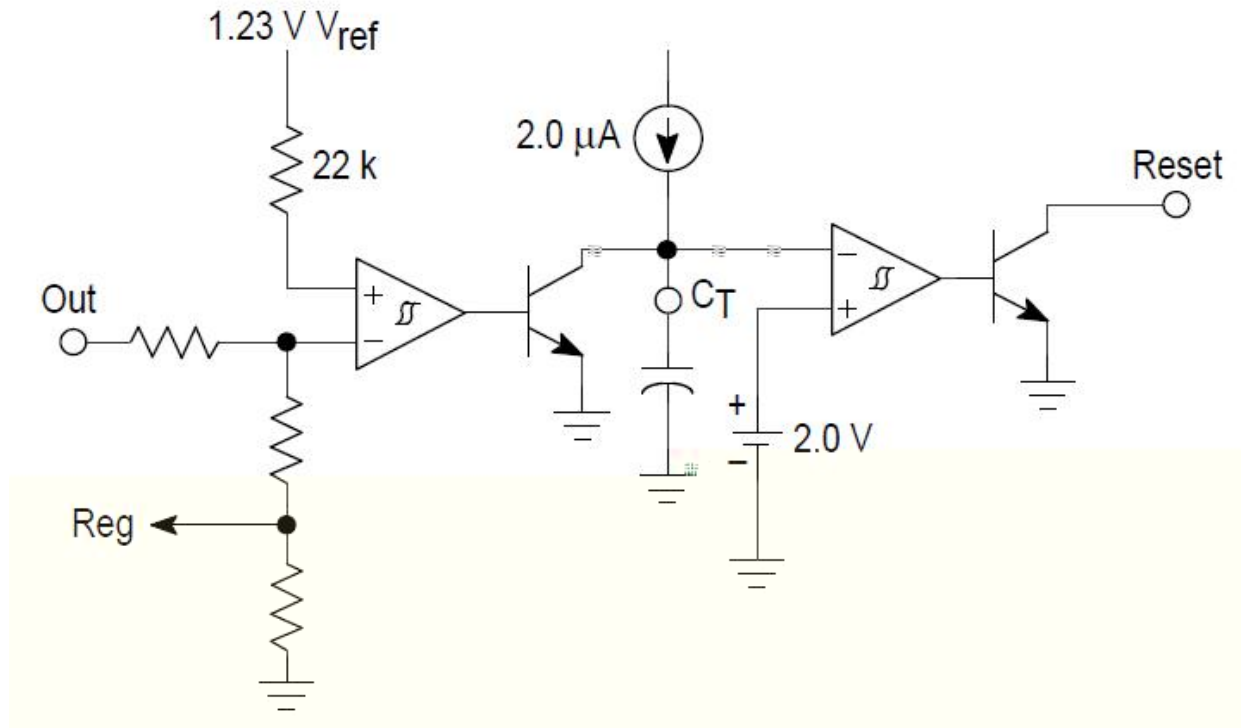

$$R_D = \frac{C \times V}{A}$$

